

Sistema NB

PROFILI A CREMAGLIERA
Pannellatura rapida ad innesto e scivolo.
Multi-spessore. Fino a 19 mm a filo

NB Series

SLOTTED PROFILES
Fast sliding-anchorage assembly.
Multi-thickness. Up to 19 mm to fit flush

4 volte più veloce di tutti i sistemi ad innesto frontale.
Nessuna lavorazione sui pannelli

Assembly 4 times faster than other panelling systems.
No tooling on panels

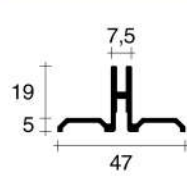

Codici Codes	Al	H
NB1.2013.	Al	2013
NB1.2531.		2531
NB1.3012.		3012

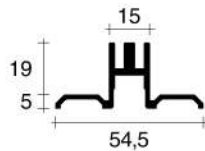

NB2.2013.		2013
NB2.2531.		2531
NB2.3012.		3012

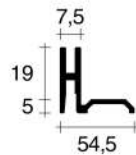
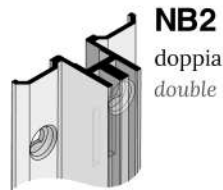

Codici Codes	Al	H
NB7.20SX.	Al	2013
NB7.25SX.		2531
NB7.30SX.		3012



NB7.20DX.		2013
NB7.25DX.		2531
NB7.30DX.		3012

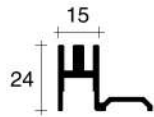

NB3.20SX.		2013
NB3.25SX.		2531
NB3.30SX.		3012



NB3.20DX.		2013
NB3.25DX.		2531
NB3.30DX.		3012

Finiture Finishings	Alluminio Aluminium	Al		Al
Argento satinato Satinized Silver	NAT		Brillante Brilliant	LUX *
Nero Black	ANE		Finitura inox Inox finishing	NOX *
Superficie simil-acciaio inox Stainless steel optical	SSO		Dorato lucido Polished gold	DOL *

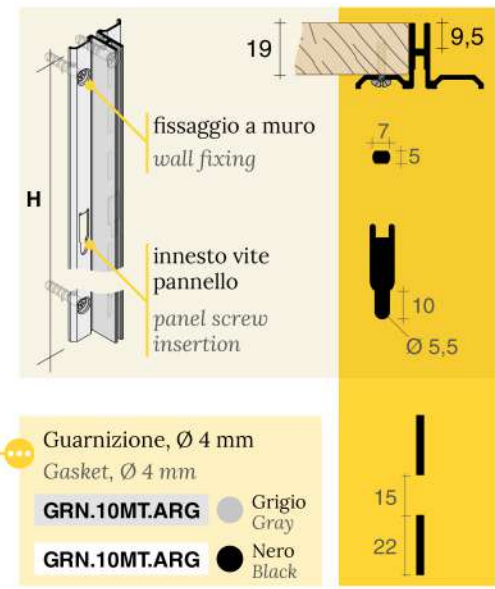
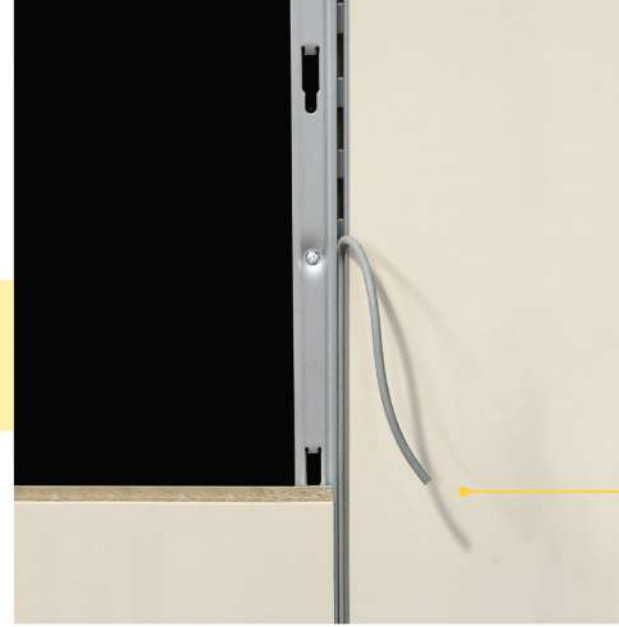

Guarnizione, Ø 4 mm
Gasket, Ø 4 mm

GRN.10MT.ARG Grigio Gray

GRN.10MT.ARG Nero Black

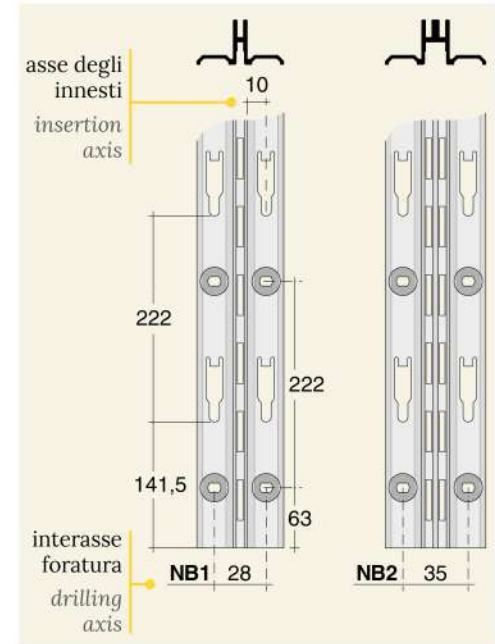
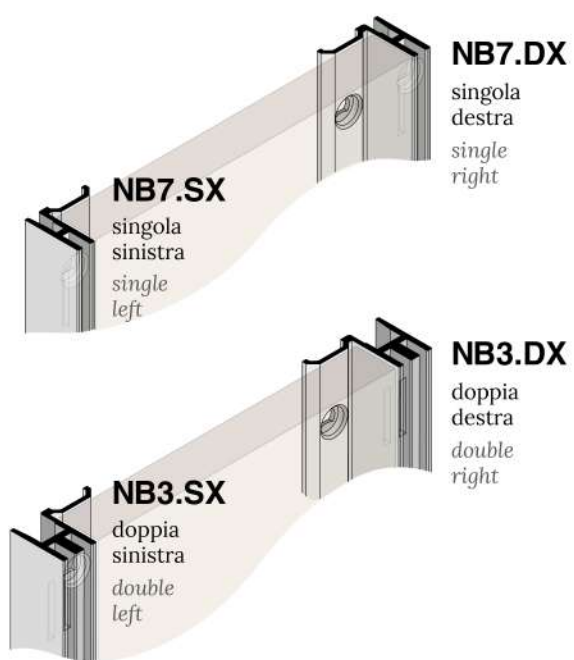

Sistema NB

PROFILI DI FINITURA
Pannellatura rapida ad innesto e scivolo.
Multi-spessore. Fino a 19 mm a filo

NB Series

FINISHING PROFILES
Fast sliding-anchorage assembly.
Multi-thickness. Up to 19 mm to fit flush

4 volte più veloce di tutti i sistemi ad innesto frontale.
Nessuna lavorazione sui pannelli

Assembly 4 times faster than other panelling systems.
No tooling on panels

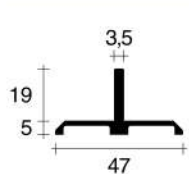
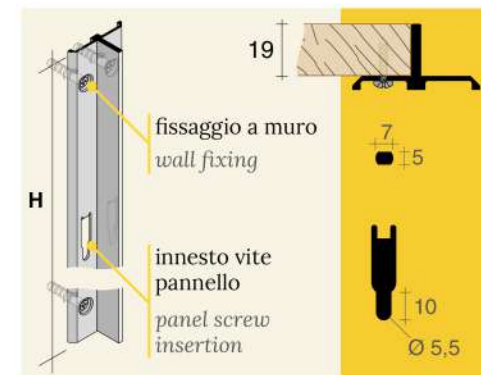

Codici Codes	Al	H
NB8.2531.	2531	
NB8.3012.	3012	



NB8
centrale
central

Protezione dei bordi dei pannelli tagliati a 45°
Protection of panel edges cut at 45°

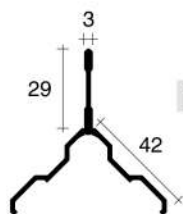

NB9.3012.	3012
-----------	------

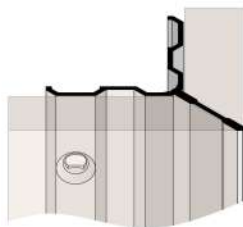

NB9
angolo esterno
external corner

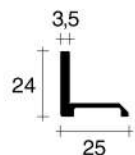

NB6.25SX.	2531
NB6.30SX.	3012

Al	H
NB6.25DX.	2531
NB6.30DX.	3012



NB6.SX
sinistra
left

NB6.DX
destra
right

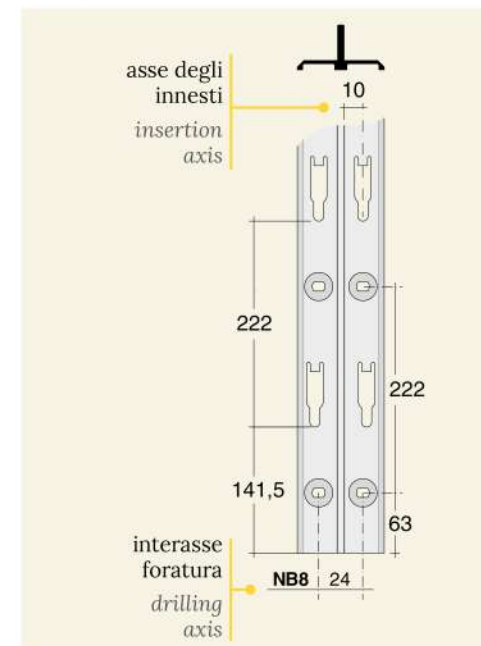

Finiture Finishings	Alluminio Aluminium	Al	Al
Argento satinato Satinized Silver	NAT	Brillante Brilliant	LUX *
Nero Black	ANE	Finitura inox Inox finishing	NOX *
Superficie simil-acciaio inox Stainless steel optical	SSO	Dorato lucido Polished gold	DOL *

codice code
XXX.XXXX.XXX*

Asterisco = la finitura potrebbe non essere in pronta consegna.
Asterisk = finishing not always ready in stock.

Finiture disponibili per profili H = 3012 mm
Finishing available for profiles H = 3012 mm

Quote espresse in millimetri.
Dimensions are in millimeters.

Accessori correlati
Related accessories

Fit
ART

Sistema NB

PROFILO INVISIBILE PER PANNELLATURA
Pannellatura rapida ad innesto e scivolo.
Multi-spessore.

NB Series

INVISIBLE PROFILE
Fast sliding-anchorage assembly.
Multi-thickness

4 volte più veloce di tutti i sistemi ad innesto frontale.
Nessuna lavorazione sui pannelli

Assembly 4 times faster than other panelling systems.
No tooling on panels



Codici Codes	Fe	H
NB0.1554.		1551
NB0.1998.		1995
NB0.2442.		2439
NB0.2886.		2883

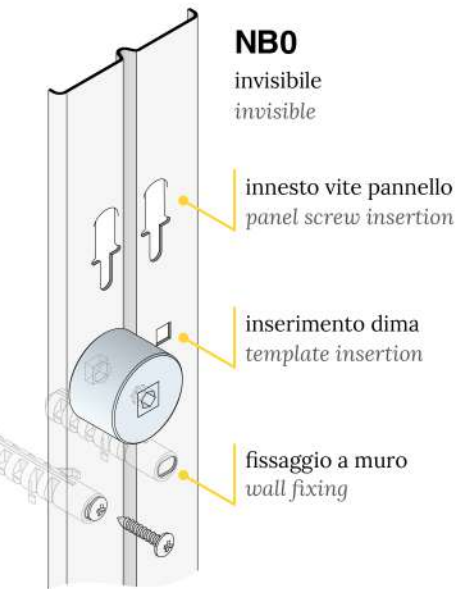

Finiture Finishings	Acciaio Steel	Fe
Zincato opaco Matt galvanized		AZN

Per confezioni > 100 pz. il codice diventa .ZIN
For packages > 100 pcs. the code becomes .ZIN

Montaggio con dime Assembly with templates

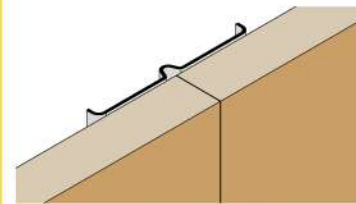

Dima per giunzione a filo
Flush junction template

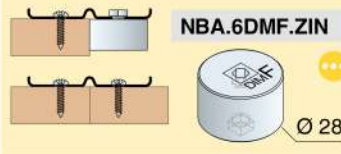

Dima per scuretto da 2 mm
2 mm spaced junction template

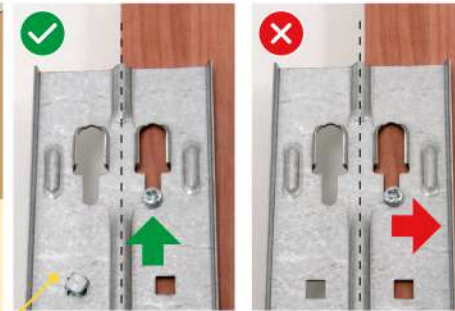
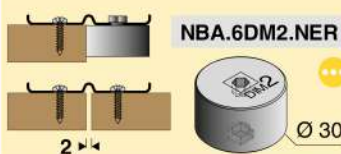

Problemi nel montaggio senza dime
Problems when mounting without templates

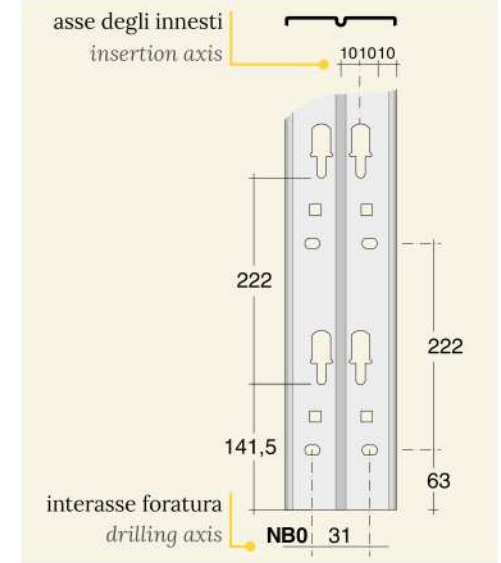
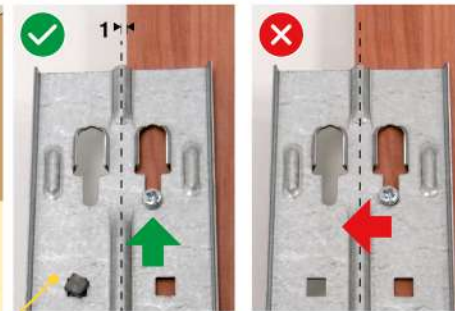

! Acciaio ad alta resistenza alla corrosione
High corrosion resistance steel

alternative
dell'angolo
interno
inside corner
alternatives

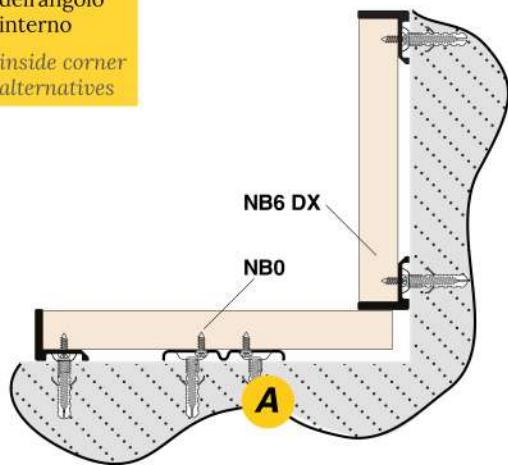

pareti in quadro e
pannelli indipendenti
right angled walls and
independent panels

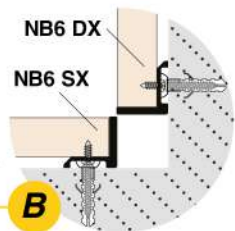

pareti anche
fuori quadro
also on not right
angled walls

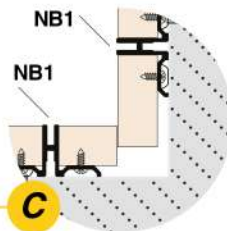

pareti anche
fuori quadro
also on not right
angled walls

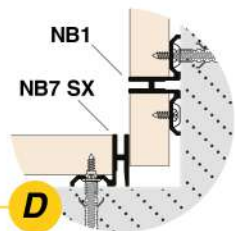

campate inferiori
a 25 cm
> 25 cm span
between profiles

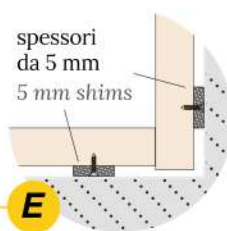

alternative
dell'angolo
corner
alternatives

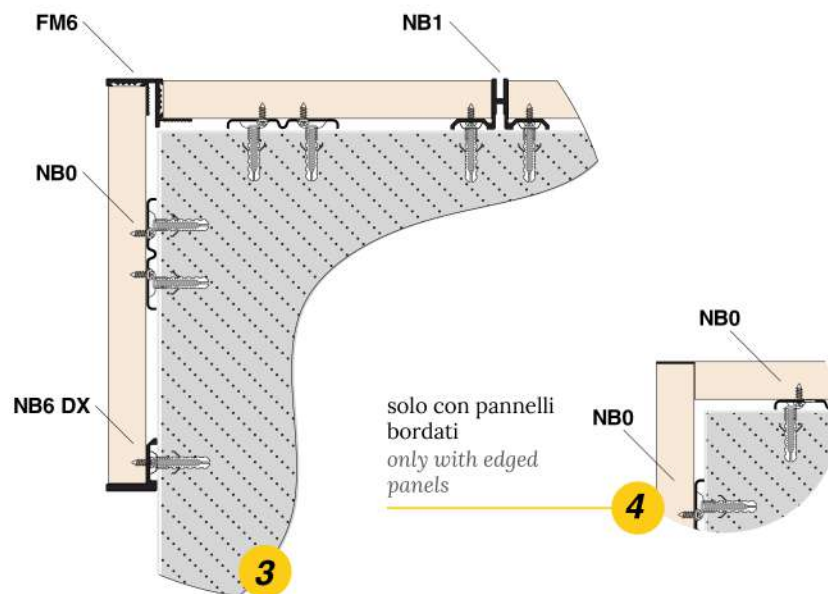
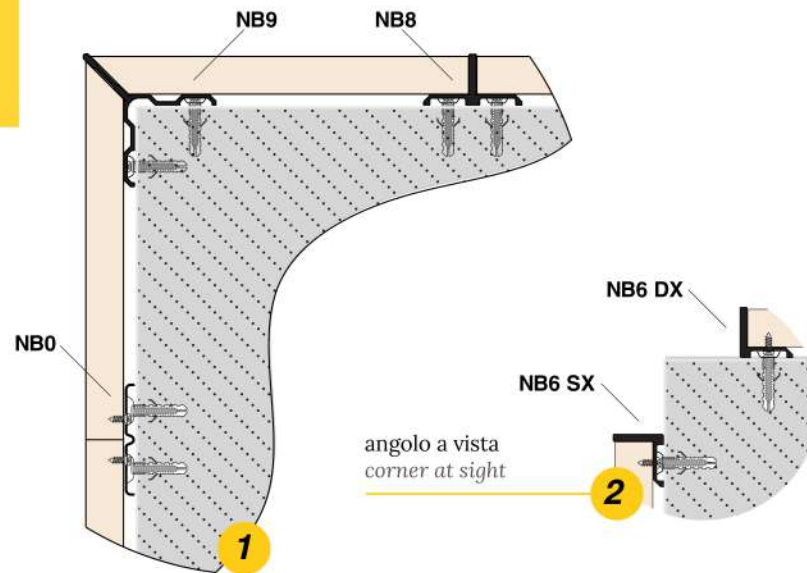

Sistema NB

NB System

VITI PER RIVESTIMENTI IN LEGNO
O MATERIALI DIRETTAMENTE AVVITABILI

SCREWS FOR WOOD PANELLING
OR DIRECTLY SCREWABLE MATERIALS



NBA.V100.ZIN

Vite di fissaggio
Fixing screw



18-19



18-19

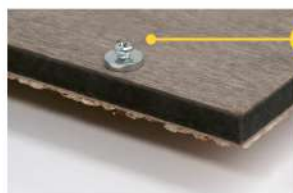

NBA.VS16.ZIN

Vite a colletto da legno
e nottolino per vite a colletto
Collar screw for wood
and spacer for collar screw



18-19

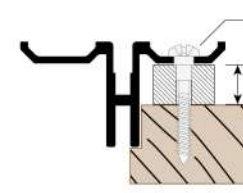

3,5 x 25
9
18-19



NBA.VS10.ZIN

Vite a colletto da legno
e nottolino per vite a colletto
Collar screw for wood
and spacer for collar screw



10

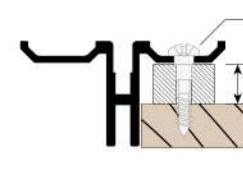

3,5 x 18,6
9
10

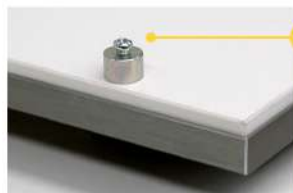

NBA.VS18.ZIN

Vite a colletto da legno
e nottolino per vite a colletto
Collar screw for wood
and spacer for collar screw



16

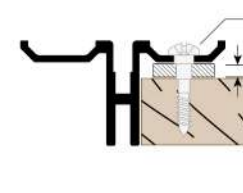

3,5 x 18,6
3
16



Uso di vite + nottolino:
segnare i fori sfruttando
il profilo come dima poi
avvitare viti e nottolini
al retro del pannello

Use of screw + spacer:
first mark the holes (use
the profile as a template),
then screw both elements
on the panel back



Sistema NB

NB System

PREPARAZIONE DEL PANNELLO
DI RIVESTIMENTO

WALL-CLADDING
PANEL PREPARATION

Per un pannello di altezza 3 m sono sufficienti 4/5 viti per lato.
Aumentare il numero di viti in caso di carichi a sbalzo o pannelli poco compatti

4/5 screws on each side is enough for a 3-meter high panel.
Increase screws quantity in case of overhang elements or panels in very light materials

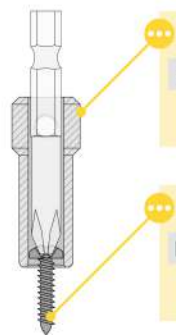

NBA.TULL.ZIN

Inserto regolabile per il controllo della profondità di avvitatura delle viti **NBA.V100.ZIN**
*Adjustable special bit insert for **NBA.V100.ZIN** tightening depth control*

NBA.V100.ZIN

Vite di fissaggio standard 3,5 x 16 mm.
Per pannelli da **18-19 mm**
*Standard fixing screw 3,5 x 16 mm.
For **18-19 mm** panel thick*

La vite si avviterà fino a raggiungere la **profondità impostata**

*The screw will stop at the **set depth***

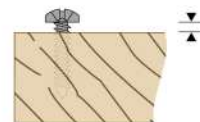

Tutti i profili NB
All NB profiles

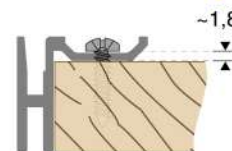

Solo NBO
NBO only

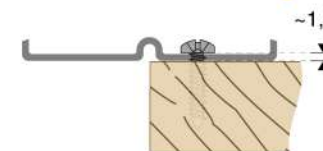

CON PRE-PUNTATURA MANUALE:
Utilizzo di un **profilo come dima** per **posizionare le viti** sul retro del pannello

WITH MANUAL PREPUNCHING:
Use of a **profile as a template** to **place the screws** on the panel back

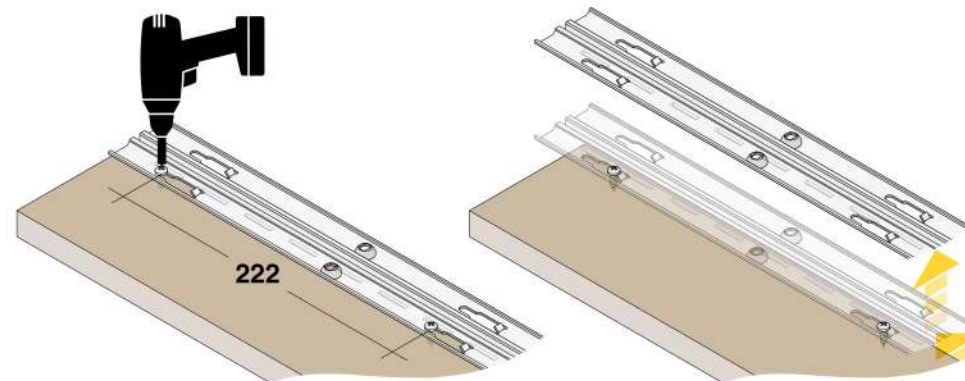

CON PRE-PUNTATURA AUTOMATICA:
Utilizzo dell'inserto **NBA.TULL** per **regolare la profondità di avvitatura** delle viti

WITH AUTOMATIC PREPUNCHING:
Use of the special bit insert **NBA.TULL** to **adjust the stop** of the screws

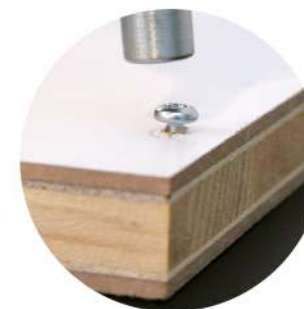

Quote espresse in millimetri.
Dimensions are in millimeters.

Accessori correlati
Related accessories

FIT
ART



- 1** Fissare il **profilo I** a muro (verificando la **messa in bolla**)
Fix **profile I** to the wall (always verifying the leveling)

- 2** Agganciare il **pannello (+ profilo II)**:
inserire le **teste delle viti** nell'**asola**,
far scivolare fino a fine corsa (**10 mm**)

Anchor the **panel (+ profile II)**:
insert the **screw heads** into the **eyelets**,
slide to the end of the stroke (**10 mm**)

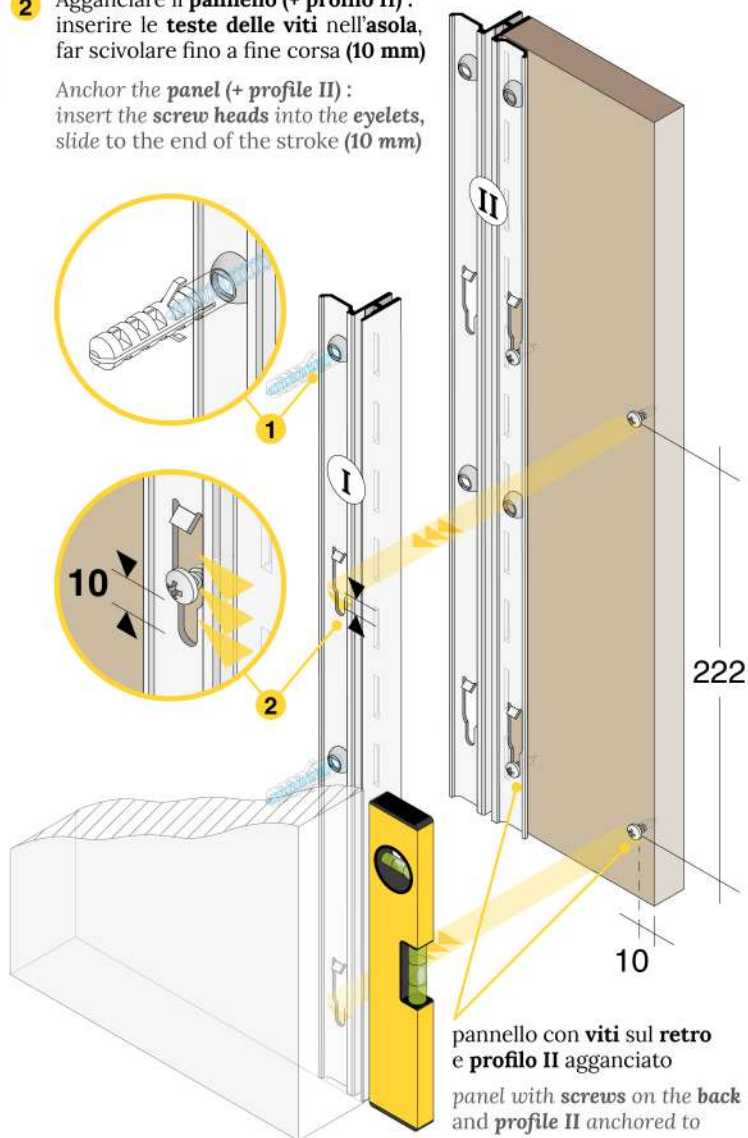

- 3** Verificare il **passo cremagliera**: appoggiare la
livella su due supporti agganciati alla stessa altezza
Check the slots pitch: place the level on two supports
hooked at the same height

- 4** Segnare la posizione dei tasselli
del **profilo II** (fori **esterni**)
Mark the plugs positions
of **profile II** (outer holes)

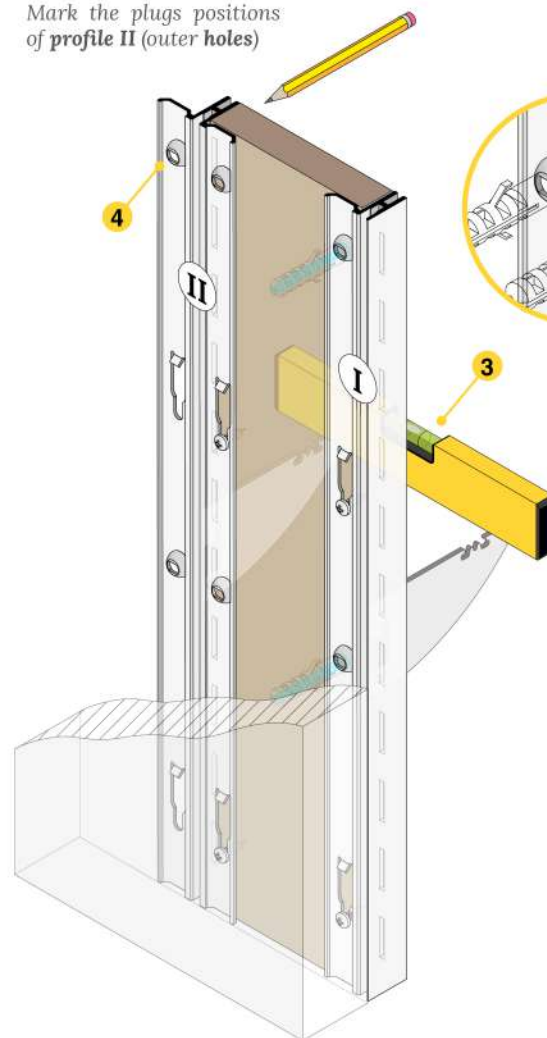

- 5** Rimuovere il **pannello** e segnare la posizione dei tasselli del
profilo II (fori **interni**_nascosti precedentemente dal pannello)
Remove the **panel** and mark the plugs positions of **profile II**
(**inner holes**_previously hidden by the panel)

- 6** Inserire tutti i tasselli per il **profilo II**
a muro (**non** attraverso il profilo)
Insert all the plugs for **profile II**
to the wall (**not** through the profile)

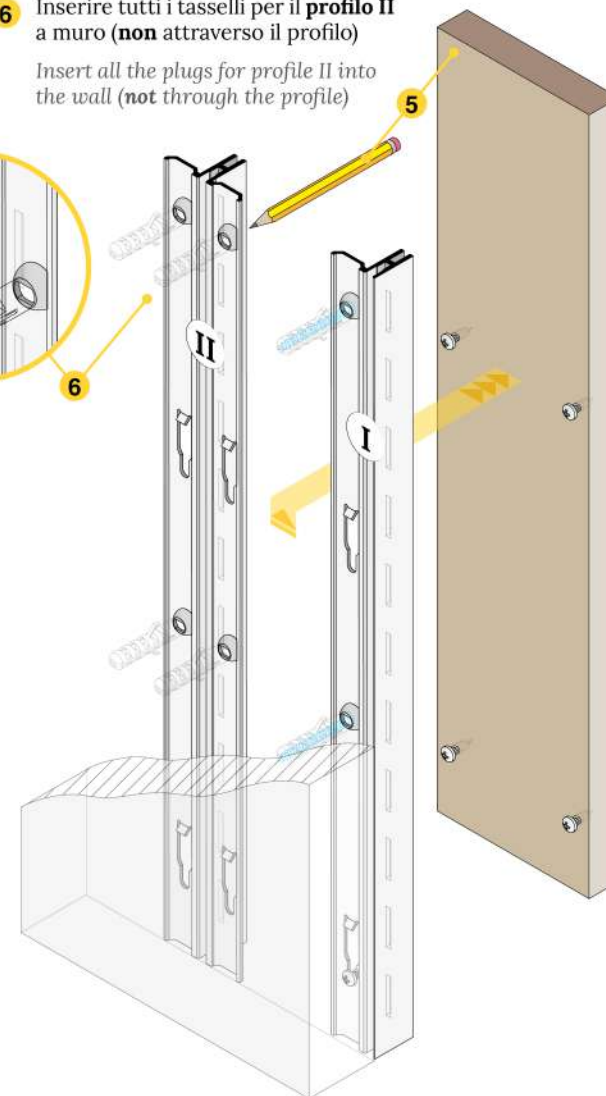

Sistema NB - cremagliere

NB Series - slotted profiles

MONTAGGIO RAPIDO A SCIVOLO
ED INCASTRO

FAST SLIDING-ANCHORAGE ASSEMBLY

7 Agganciare il **pannello**

Anchor the **panel**

8 Verificare il **passo cremagliera** con la livella

Check the **slots pitch** using a level

9 Tassellare il **profilo II** (fori **esterni**)

Fix **profile II** to the wall (**outer holes**)

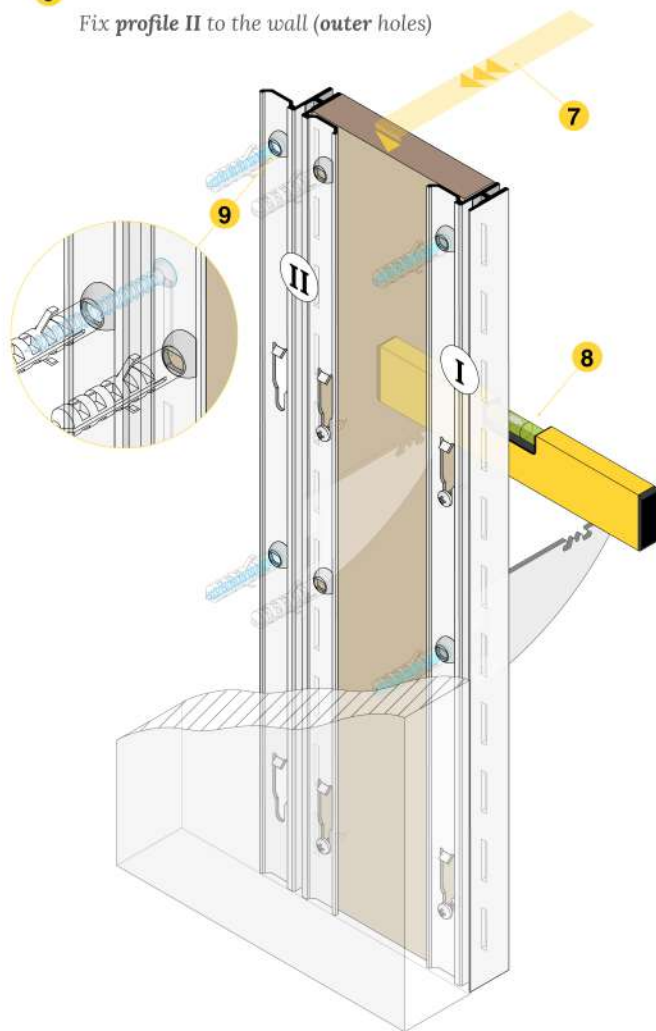

10 Rimuovere il **pannello**

Remove the **panel**

11 Tassellare il **profilo II**
(fori **interni**_ nascosti precedentemente dal pannello)

Fix **profile II** to the wall
(**inner holes**_ previously hidden by the panel)

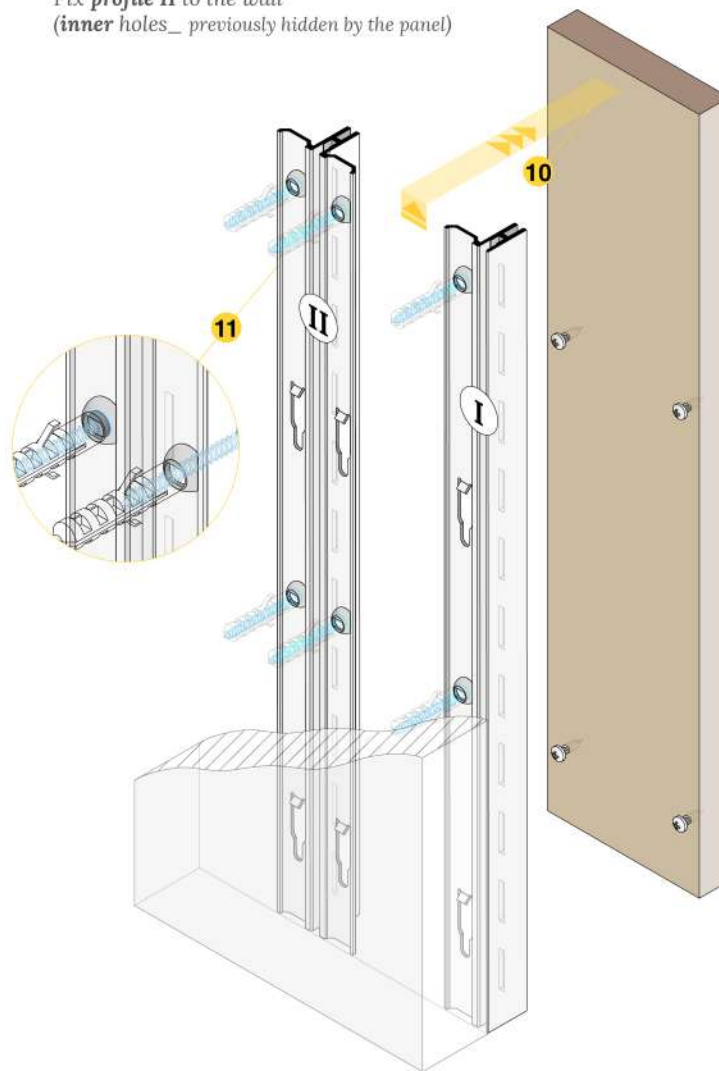

12 Agganciare il **primo pannello**
ai profili I e II

Anchor the **first panel**
to profile I and II

2 **12** Ripetere la procedura per tutti
i **profili (e pannelli) successivi**
Repeat the procedure for all
other profiles (and panels)

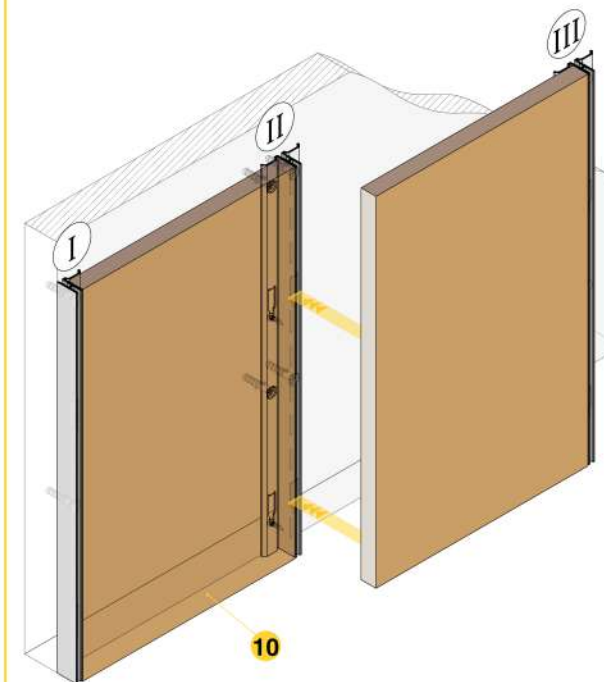

Quote espresse in millimetri.
Dimensions are in millimeters.

Accessori correlati
Related accessories

FIT
ART



Profilo NB0 - montaggio

NB0 profile - assembly

POSIZIONAMENTO DELL VITI E MONTAGGIO
DEL RIVESTIMENTO CON PROFILI NB0

SCREW PLACEMENT AND WALL CLADDING
WITH NB0 PROFILES

Uso del **profilo NB0 + dime** per il **posizionamento delle viti** sul retro pannello

Screw placement on the panel back using NB0 profile + templates

lato retro pannello
panel back side

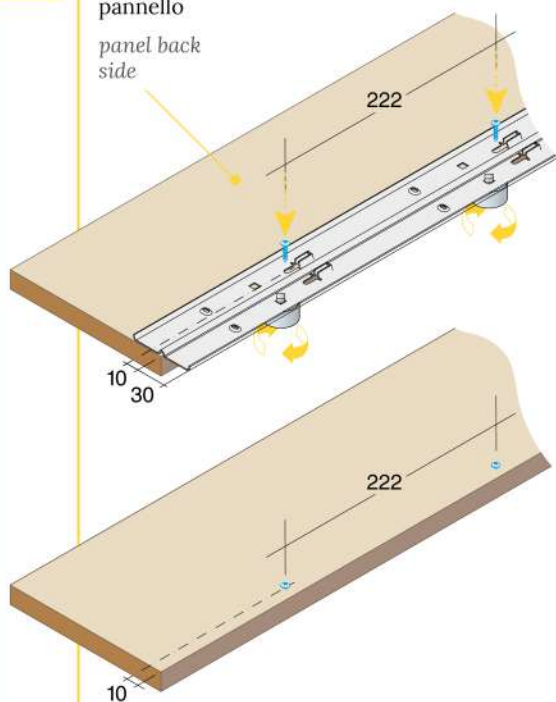

In alternativa possono essere usati i **profili NB1 / NB2 / NB8** come **dima** (per montaggi con pannelli a filo)

As an alternative NB1 / NB2 / NB8 profiles can be used as a template (for flush panel mounting)

Uso delle **dime** per la **regolazione** ed il **montaggio** di profili e pannelli

Panel and profile adjustment and fixing using templates

- 1** Fissare a parete il **profilo I** (verificando la messa in bolla)
Fix **profile I** to the wall (always verifying the leveling)
- 2** Montare 3 dime sul **profilo I** (fori esterni)
Insert 3 templates into **profile I** (outer holes)
- 3** Agganciare: **pannello + profilo II + 3 dime**
Anchor: **panel + profile II + 3 templates**

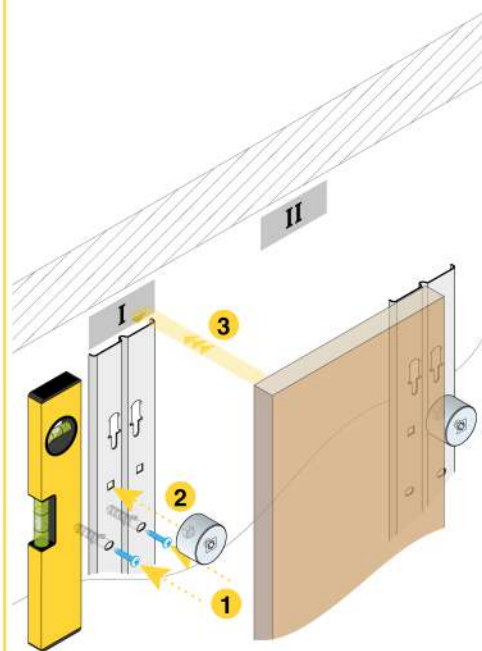

- 4** Segnare la **posizione dei tasselli** per il **profilo II** (fori esterni)
Mark the **plugs positions** for **profile II** (outer holes)
- 5** Verificare l'allineamento della base dei profili e del pannello
Verify the alignment of the profiles and the panel lower part

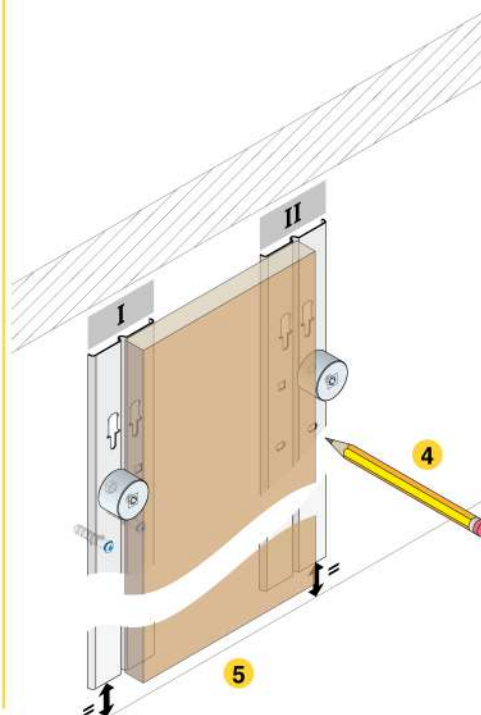

- 6** Rimuovere il pannello e segnare la **posizione dei tasselli** per il **profilo II** (fori interni)
Remove the panel and mark the **plugs position** for **profiles II** (inner holes)
- 7** Inserire tutti i tasselli per il **profilo II** a muro (**non** attraverso il profilo)
Insert all the plugs for **profile II** into the wall (**not** through the profile)
- 8** Rimuovere le **dime** dal **profilo II**
Remove the **templates** from the **profile II**

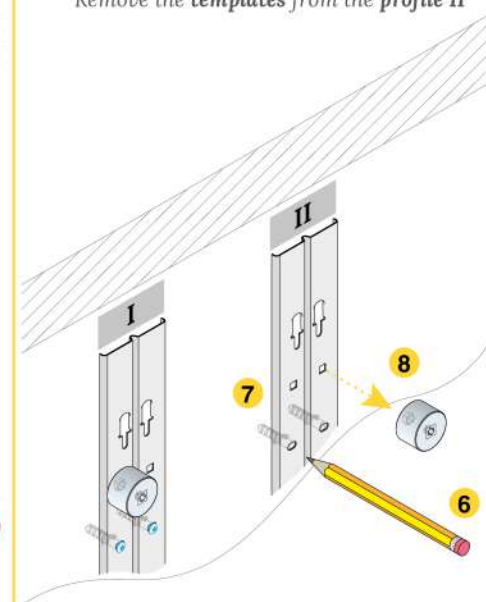

- 9** Agganciare il **pannello** ai profili I e II
Anchor the panel to profile I and II
- 10** Montare 3 dime sul **profilo II** (fori esterni)
Insert 3 templates into profile II (outer holes)
- 11** Tassellare il **profilo II** (fori esterni)
Fix profile II to the wall (outer holes)

Regolare la
messa in bolla
*Adjust the
leveling*

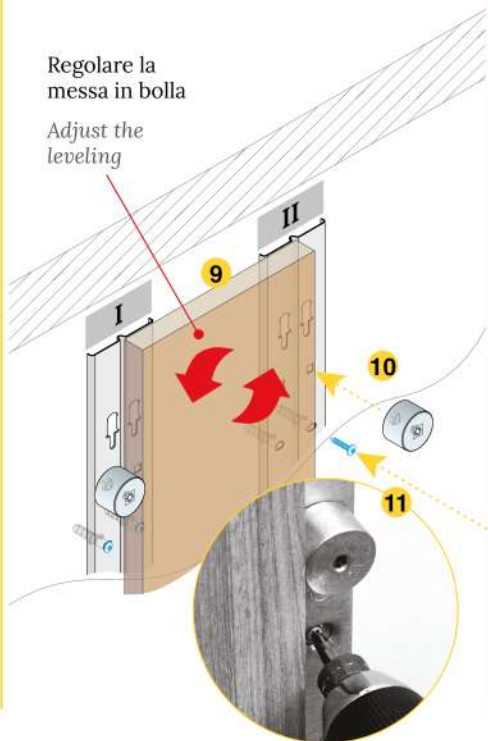

- 12** Rimuovere il pannello e le dime dal **profilo II**
Remove the panel and the templates from profile II
- 13** Tassellare il **profilo II** (fori interni nascosti precedentemente dal pannello)
Fix profile II to the wall (inner holes previously hidden by the panel)

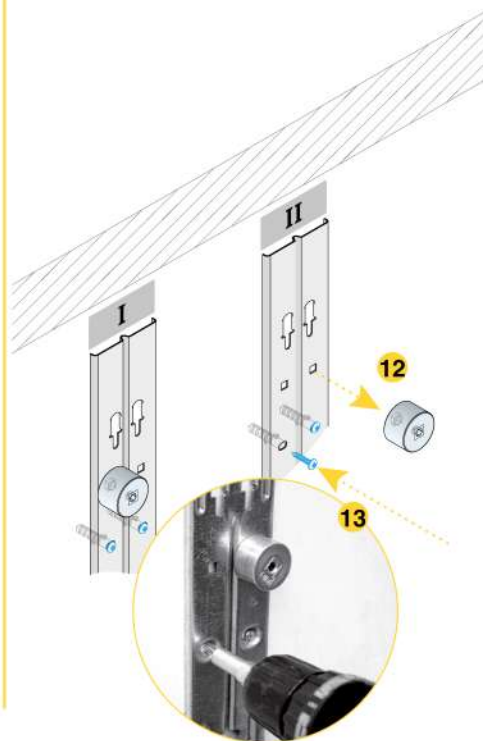

- 14** Agganciare il **pannello** ai profili I e II
Anchor the panel to profile I and II
- 15** Montare 3 dime sul **profilo II** (fori esterni)
Insert 3 templates into profile II (outer holes)
- 16** Verificare l'allineamento della base dei profili e del pannello
Verify the alignment of the profiles and the panel lower part

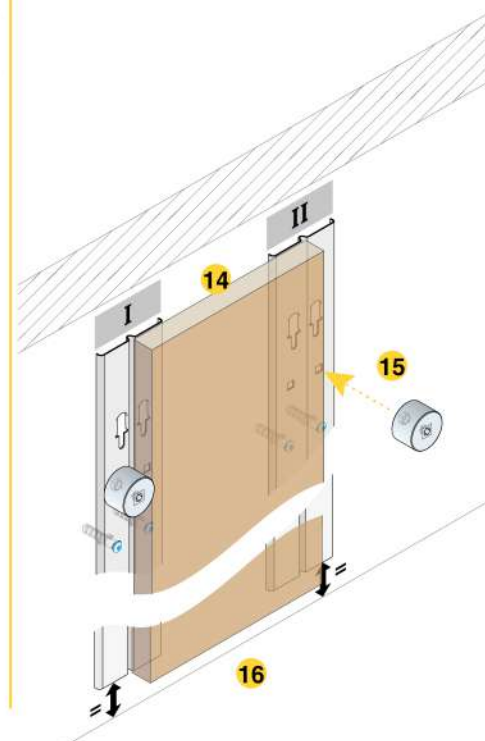

- 17** Rimuovere le dime dal **profilo II**
Remove the templates from profile II
- 2** **17** Ripetere la procedura per tutti i profili (e pannelli) successivi
Repeat the procedure for other profiles (and panels)

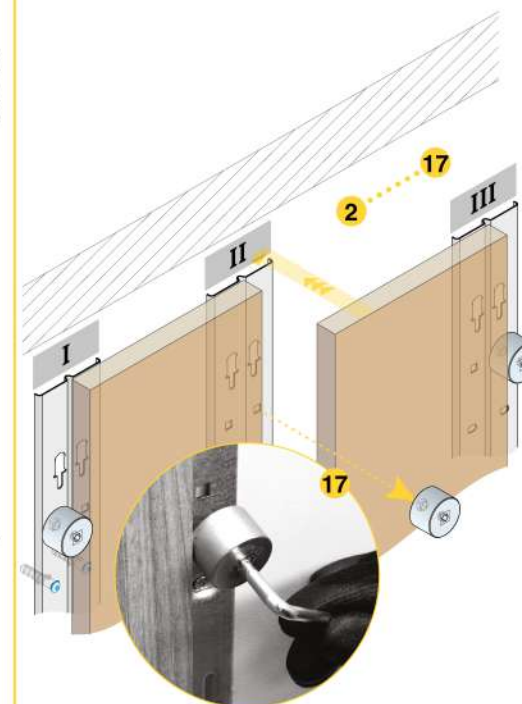

Porta NB a filo pannello

NB Flush Door

Porta raso pannellatura su NB

Door flush with paneling on NB

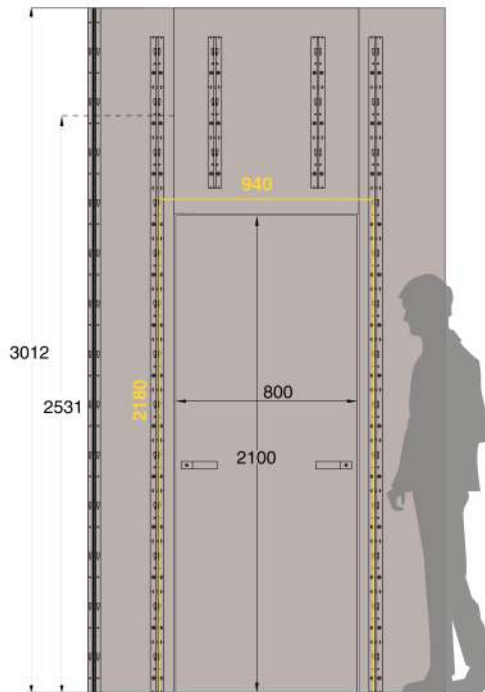

Luce Netta: 940 Altezza Netta: 2180
Door Jamb: 940 Height left: 2180

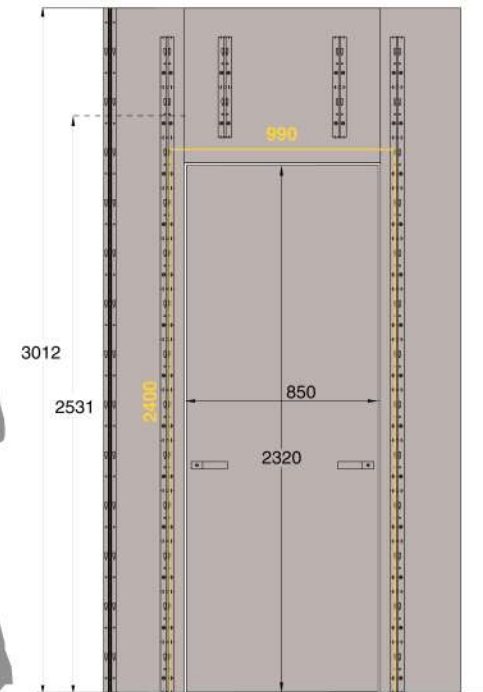

Luce Netta: 990 Altezza Netta: 2400
Door Jamb: 990 Height left: 2400

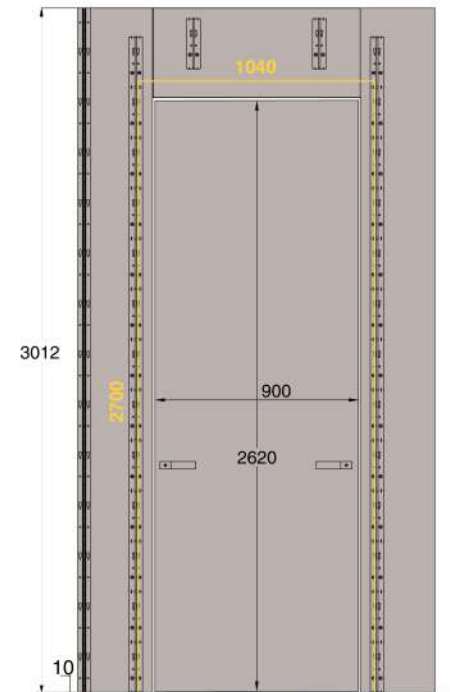

Luce Netta: 1040 Altezza Netta: 2700
Door Jamb: 1040 Height left: 2700

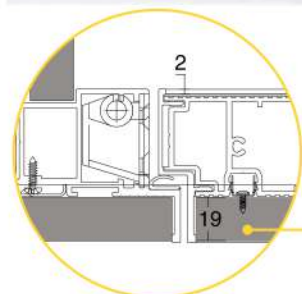

Clipsaggio del pannello alla porta

Clip panel to the door

Spinta a sinistra

Push left



NBD.210.80SX.____



NBD.232.85SX.____



NBD.262.90SX.____

Spinta a destra

Push right



NBD.210.80DX.____



NBD.232.85DX.____



NBD.262.90DX.____

Finiture Finishings	Alluminio Aluminium	AI
Argento satinato Satinized Silver		NAT
Superficie simil-acciaio inox Stainless steel optical		SSO
Nero Black		ANE*

codice code
XXX.XXXX.XXX*

Asterisco = la finitura potrebbe non essere in pronta consegna.
Asterisk = finishing not always ready in stock.

Finiture disponibili per profili H = 3012 mm
Finishing available for profiles H = 3012 mm

Quote espresse in millimetri.
Dimensions are in millimeters.

Accessori correlati
Related accessories

Porta NB a filo pannello

Porta raso pannellatura su NB

NB Flush Door

Door flush with paneling on NB

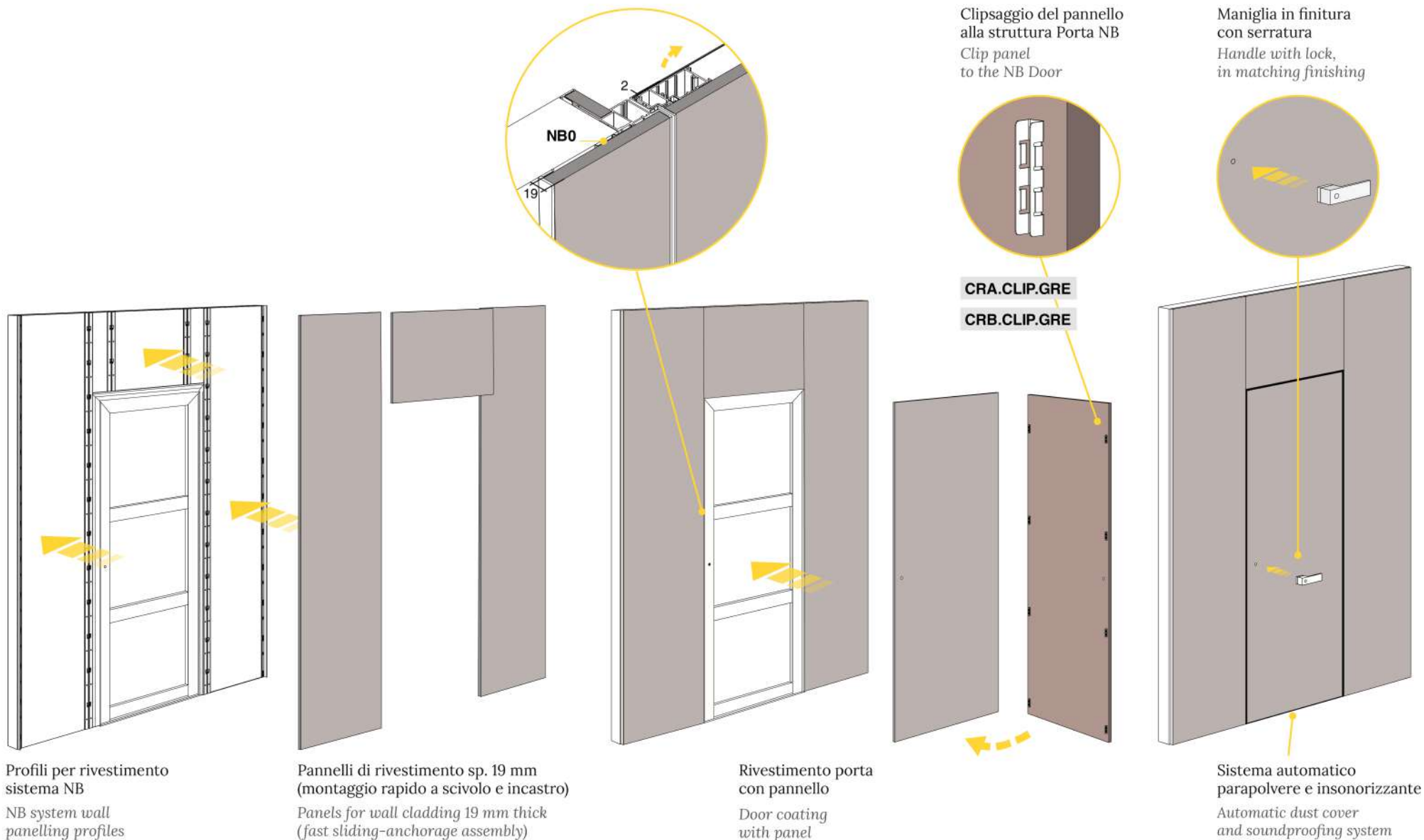

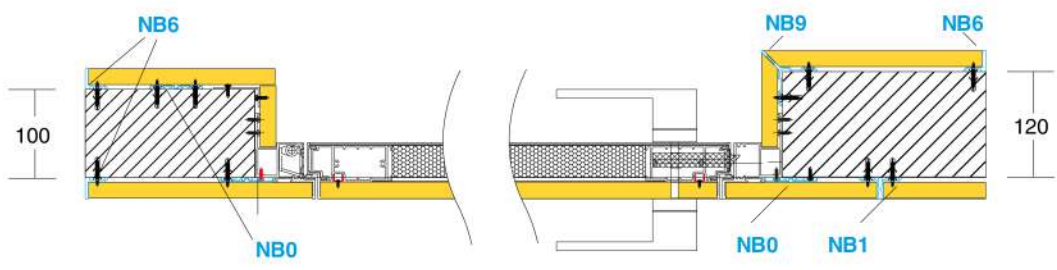

ZK6

PROFILO PER ZOCCOLATURA compatibile con sistema NB

ZK6

SKIRTING PROFILE match with NB system

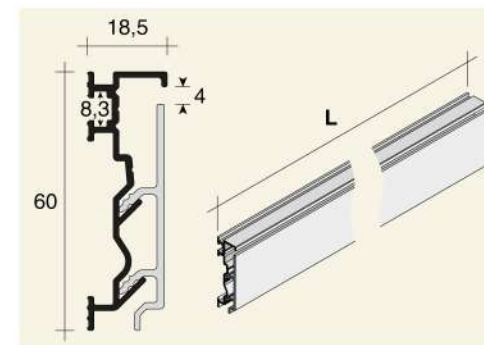

Possibilità di luce interna e rivestimento in finitura

Housing for lighting and matching cover

Cremagliere
Slotted profiles

Codici
Codes



H

ZK6.3000. ___ 3000

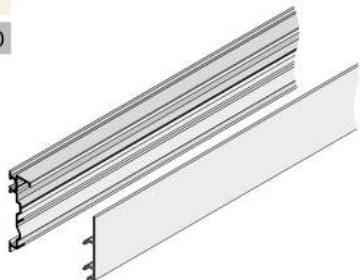

Possibilità di rivestire
e verniciare in colore
Possibility to coat
and paint in color

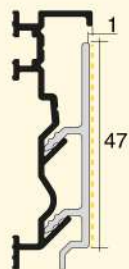

Finiture Finishings	Alluminio Aluminium	Al
Superficie simil-acciaio inox Stainless steel optical		SSO
Argento satinato Satinized Silver		NAT

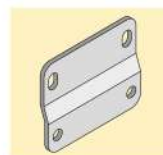

PST.FMH2.ZIN

24

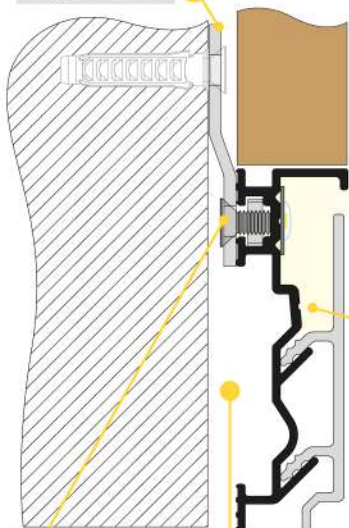

DAQ.S8M4.ZIN

punto di foratura
per l'uscita del cavo
di alimentazione
drilling point
for power cable
output

intercapedine per il
passaggio dei cavi
cavity for the
electrical cables
passage

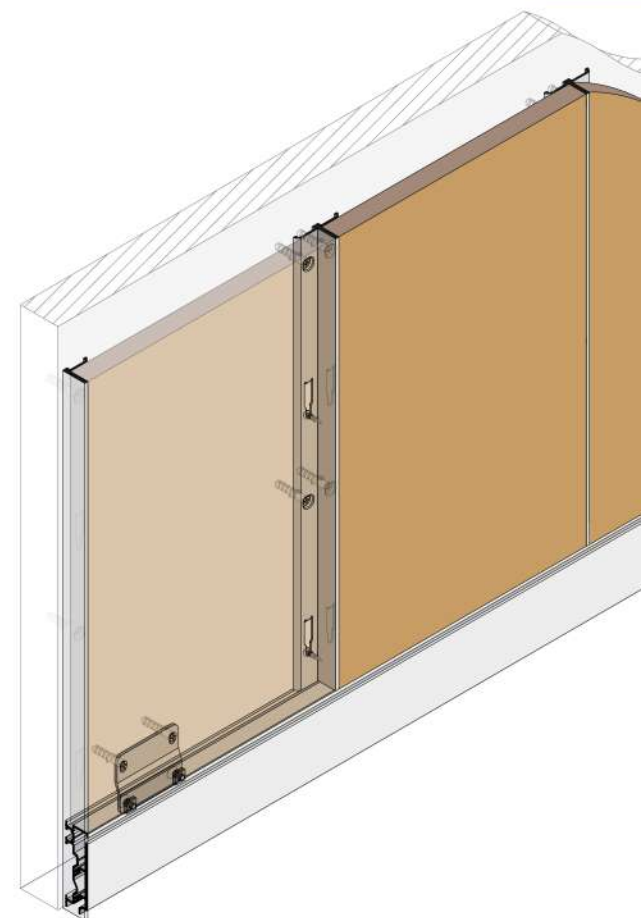

codice code
XXX.XXXX.XXX*

Asterisco = la finitura potrebbe non essere in pronta consegna.
Asterisk = finishing not always ready in stock.

Finiture disponibili per profili H = 3012 mm
Finishing available for profiles H = 3012 mm

Quote espresse in millimetri.
Dimensions are in millimeters.

Accessori correlati
Related accessories

FIT
ART

Sistema NB

NB System

PANNELLATURA
A FILO DEL SOFFITTO

FLUSH
CEILING PANELLING

Pannello inserito dal basso verso l'alto, sostenuto da espansore e coperto da zoccolino

Panel insertion from downward to upward, supported by leveller and covered by skirting profile

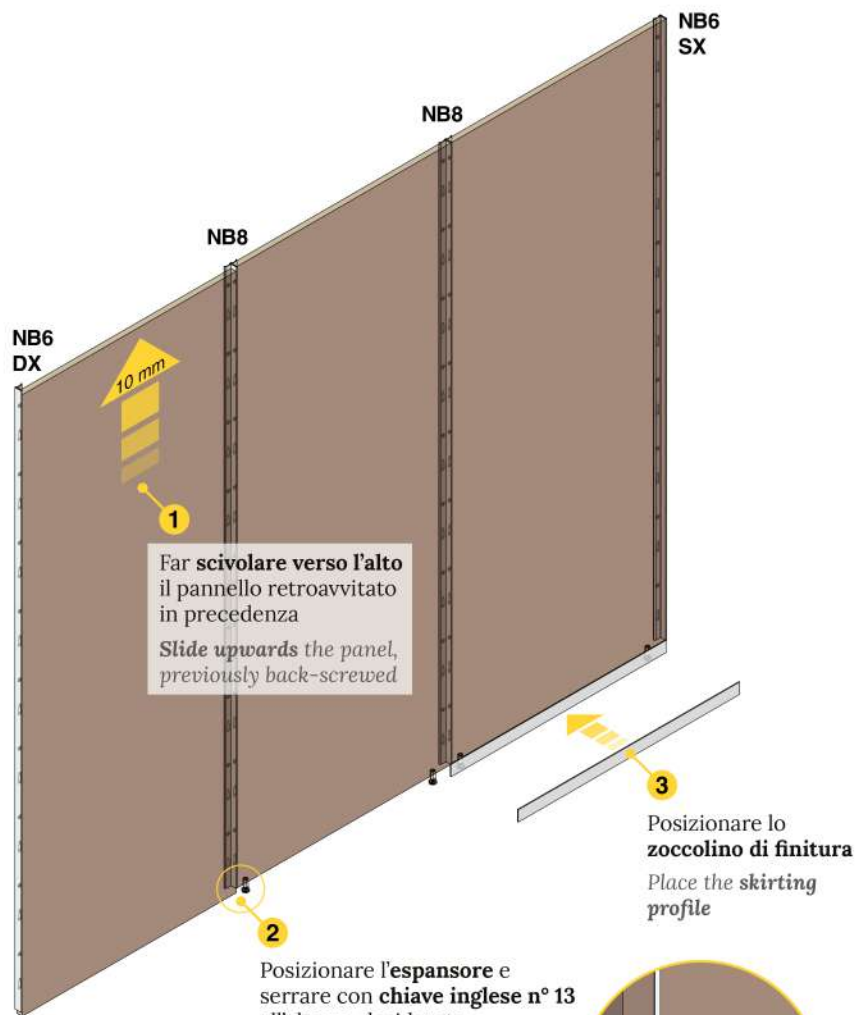

Far scivolare verso l'alto il pannello retroavvitato in precedenza
Slide upwards the panel, previously back-screwed

2 Posizionare l'espansore e serrare con chiave inglese n° 13 all'altezza desiderata
Place the leveller and tighten with wrench n° 13 to the desired height

3 Posizionare lo zoccolino di finitura
Place the skirting profile

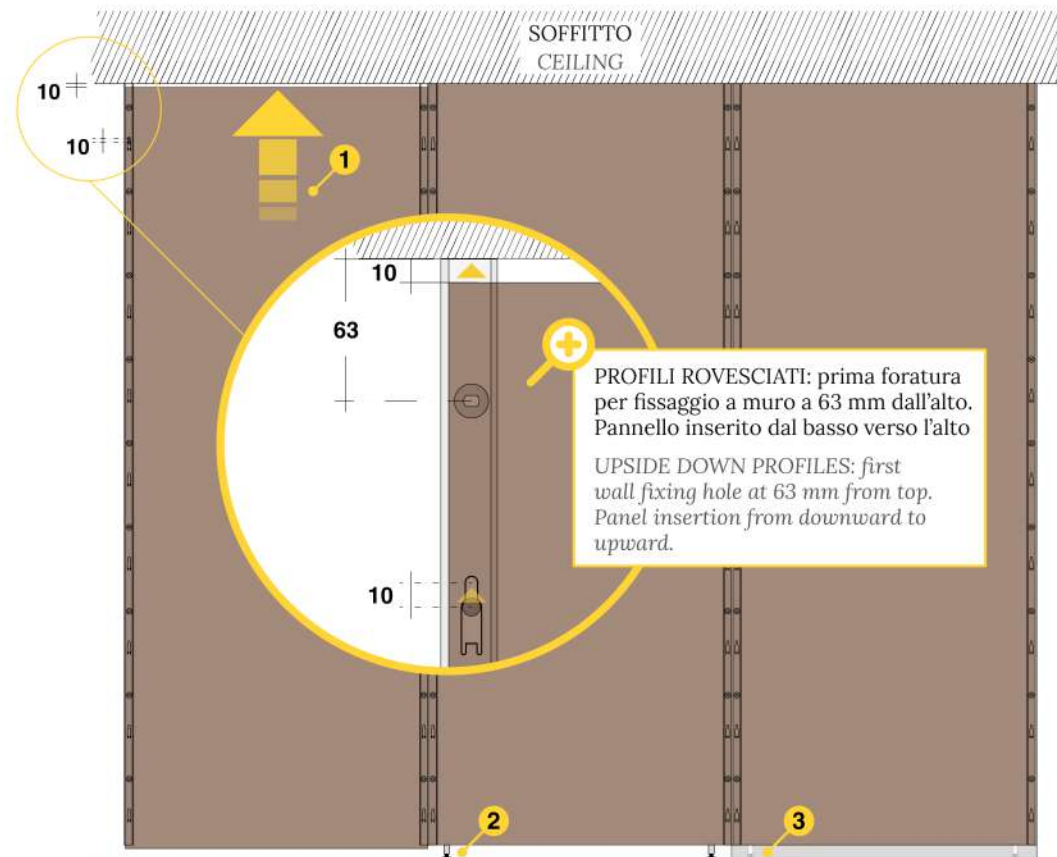
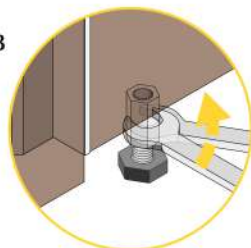

PROFILI ROVESCIATI: prima foratura per fissaggio a muro a 63 mm dall'alto. Pannello inserito dal basso verso l'alto.
UPSIDE DOWN PROFILES: first wall fixing hole at 63 mm from top. Panel insertion from downward to upward.

**Espansore
Leveller**

**Escursione
Excursion**

	min	MAX
ESP.3145.ZIN	~ 31	~ 45
ESP.3755.ZIN	~ 37	~ 55
ESP.4765.ZIN	~ 47	~ 65
ESP.5775.ZIN	~ 57	~ 75

Quote espresse in millimetri.
Dimensions are in millimeters.

Accessori correlati
Related accessories

Sistema NB

PROFILO B10

Profilo per lastre ad esso incollate o avvitate

NB System

B10 PROFILE

Profile for slabs to be glued or screwed on it.

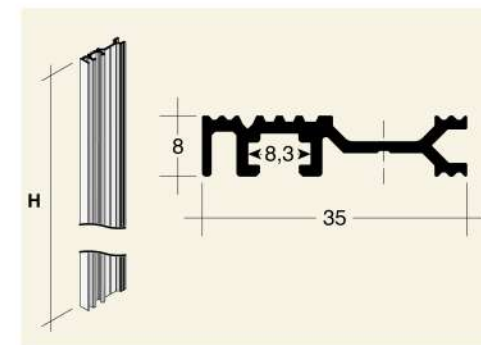
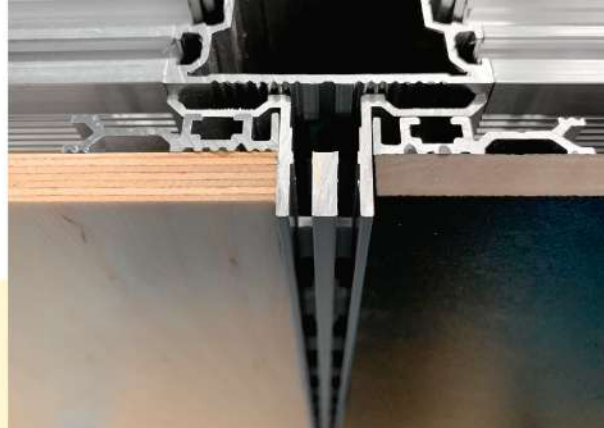

Cremagliere
Slotted profiles

Per il montaggio rapido ad aggancio e scivolo sui profili del sistema NB con l'utilizzo viti di sostegno regolabili

For fast sliding-anchorage assembly with adjustable screws on NB system

B10

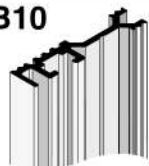

Codici Codes	Al	H
B10.3000.	—	3000

Fasi di montaggio

Assembly steps

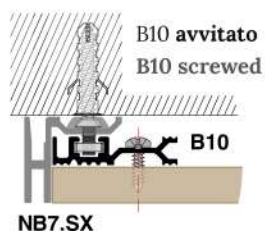
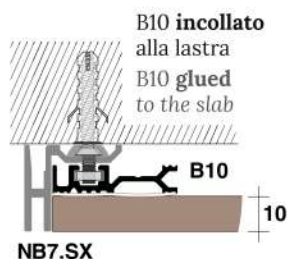

NB7.SX

NB1

222

222

Finiture Finishings	Alluminio Aluminium	Al
Argento satinato Satinized Silver	NAT	consigliata per incollaggio recommended for gluing
Grezzo Raw	AGR	

codice code
XXX.XXXX.XXX*

Asterisco = la finitura potrebbe non essere in pronta consegna.
Asterisk = finishing not always ready in stock.

Finiture disponibili per profili H = 3012 mm
Finishing available for profiles H = 3012 mm



1 **incollare** il profilo B10 al retro della lastra
to glue the B10 profile on the back of the slab

utilizzare collanti professionali / omologati
use professional / homologated glues

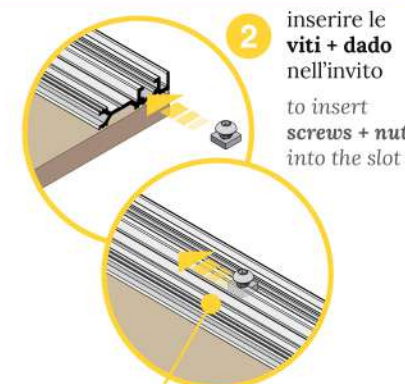

2 **inserire le viti + dado** nell'invito
to insert screws + nut into the slot



DAQ.NEQ8.ZIN

novità
new items
2019

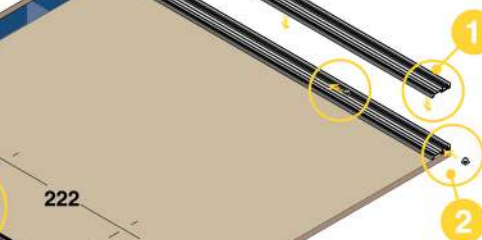

3 **utilizzare un profilo-dima NB** e posizionare ogni **vite + dado** all'altezza di un'asola di aggancio. Far scorrere la vite a fine corsa

use a NB profile-temple and position each screw + nut at the height of a hooking slot. Slide the screw to the end of the stroke.

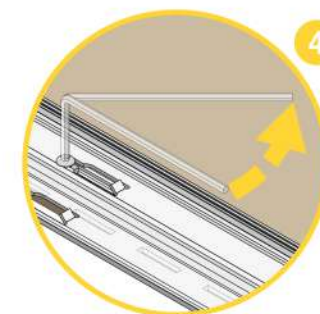

4 **serrare la vite con brugola**
tighten the screw with Allen key

Quote espresse in millimetri.
Dimensions are in millimeters.

Accessori correlati
Related accessories

Fit
ART

Sistema NB

NB System

RIVESTIMENTI IN MATERIALE LAPIDEO
O COMPOSITI a partire da 10 mm di spessore

STONE OR COMPOSITE WALL CLADDING
thickness from 10 mm

Fresa per materiali
Solid Surface.
Per alloggiamento
inserti LPT/LPS
*Drill for Solid Surface.
For LPT/LPS inserts.*



Foretto diamantato per
pietre, marmi, graniti.
Per alloggiamento
inserti LPT/LPS
*Diamond core drill for
stone, marble, granite.
For LPT/LPS inserts*

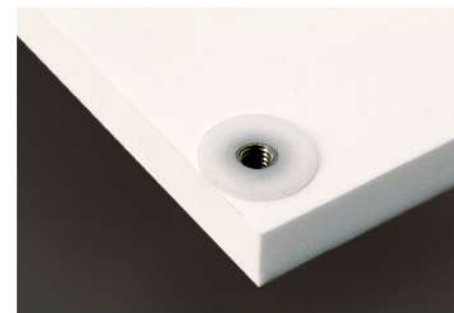

- Vite M4
- Rondella adesiva ammortizzante
- Perno in acciaio
- M4 screw
- Adhesive shock absorbing washer
- Steel pin

Inserti filettati autoancoranti a pressione M6
Press in self-anchoring threaded insert M6



2x



LPS.M6C2.INX



LPT.M6C4.INX

4x



LPS.M6C4.INX

- Vite M4
- M4 screw



VTB.M410.ZIN

Inserto filettato autoancorante a pressione M4

Press in self-anchoring threaded insert M4

4x



LPS.M4C4.INX



NBA.LP12.ZIN

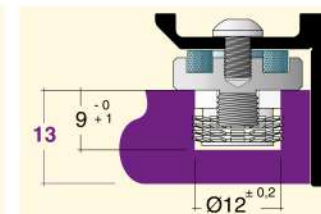
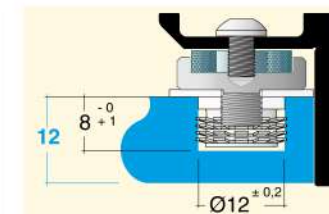
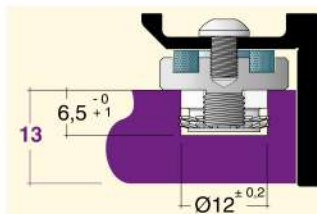
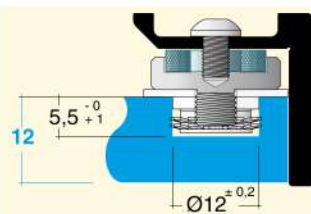

NBA.LP10.ZIN

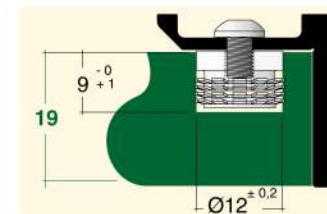
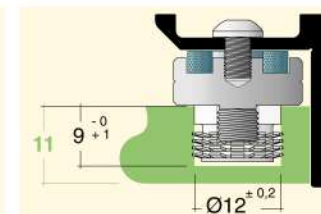
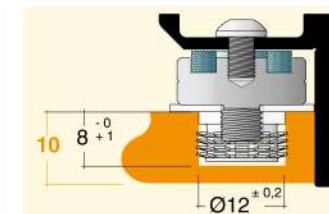
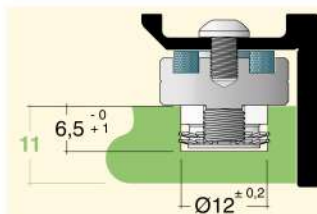
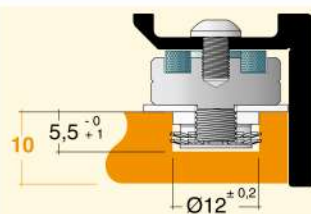

Tenuta ad estrazione fino a
Average pull-out strength up to

170

250

290

350

350

Sistema NB

PROFILO TL5 PER TELAI
Accoglie lastre da 3, 4 o 5 mm di spessore

NB System

TL5 FRAME PROFILE
For 3, 4 or 5 mm thick slabs

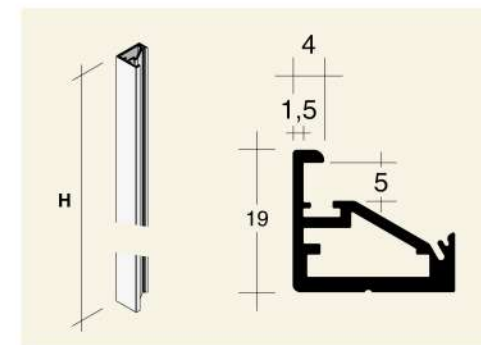

Cremagliere
Slotted profiles

TL5

Telaio
Frame

Codici Codes	Al	H
TL5.3012.		3000

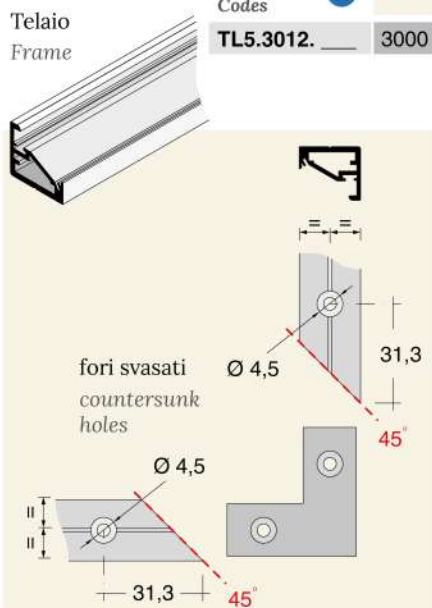

Finiture Finishings	Alluminio Aluminium	Al
Argento satinato Satinized Silver		NAT
Brillante Brilliant		LUX
Superficie simil-acciaio inox Stainless steel optical		SSO
Nero Black		ANE*
Dorato lucido Polished gold		DOL*

Montaggio del telaio

Slabs frame assembly

Squadretta con
viti Ø 4,5 mm
Junction bracket
with Ø 4,5 mm
screws

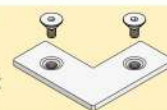

GNT.TL5A.ZIN



Dimensione della lastra

Slab dimension

RETROILLUMINAZIONE
UNIFORME
Zone d'ombra ridotte
al minimo
UNIFORM
BACKLIGHTING
Shady areas reduced
to the minimum

X = Interasse cremagliere
Distance between profiles

Y = Larghezza telaio
Frame width

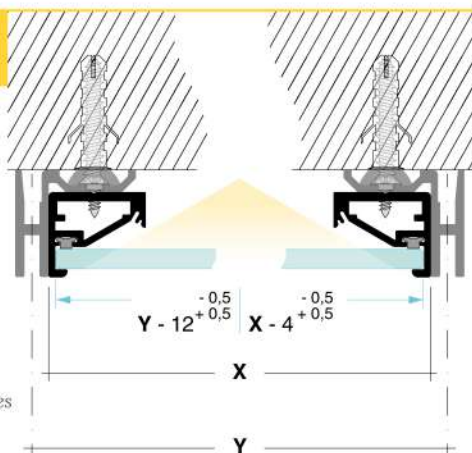

1. **Forare e svasare** (vite Ø 4,5) in corrispondenza dei fori delle squadrette.
2. Eseguire il **taglio a 45°** sugli estremi del profilo.
3. Inserire la **guarnizione** in base allo spessore della lastra.
4. Assemblare il telaio sui **3 angoli** serrando le viti delle squadrette interne.
5. Inserire la **lastra** nel telaio.
6. Serrare la squadretta del **quarto angolo** per terminare il montaggio.

1. **Drill and countersink** (for screw Ø 4,5) matching with the bracket holes.
2. **Cut the ends of the profile at 45°.**
3. Insert the **gasket** according to slab thickness.
4. Assemble the frame on **3 angles** by tightening the screws of the internal brackets.
5. Insert the **slab** into the frame.
6. Tighten the bracket of the **fourth angle** to finish the assembly.

Le lavorazioni indicate possono essere eseguite **su richiesta**
The above described toolings can be realized **on request**

Telaio retro-avvitato

Back screwed frame



Posizionare le viti autoflettanti - invito per foratura sul retro del profilo TL5 - con passo 222 mm, per il **montaggio in battuta a filo, ad innesto e scivolo su profili della serie NB.**

Place self-threading screws - pilot hole on the back of the TL5 profile - with drilling pitch 222 mm. **Fast sliding-anchorage assembly on NB series profiles and fit flush**

codice code
XXX.XXXX.XXX*

Asterisco = la finitura potrebbe non essere in pronta consegna.
Asterisk = finishing not always ready in stock.

Finiture disponibili per profili H = 3012 mm
Finishing available for profiles H = 3012 mm

Quote espresse in millimetri.
Dimensions are in millimeters.

Accessori correlati
Related accessories

FIT
ART

Sistema NB

PROFILO LMT
Telaio porta tessuto su sistema NB
con viti di sostegno regolabili

NB System

LMT PROFILE
Stretched fabric frame on NB system
with sliding adjustable screws

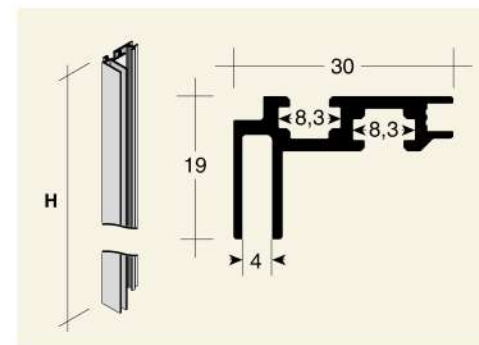
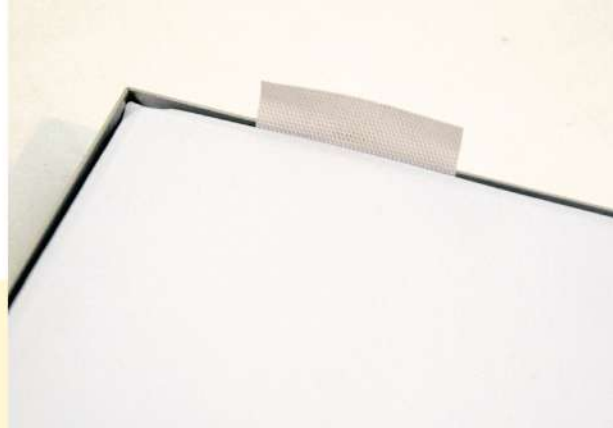

A richiesta tessuto su misura e stampa

Customized and printing fabric on request

LMT

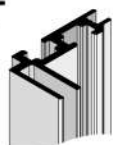

Codici Codes	Al	H
LMT.3000.	—	3000



NB7.SX

Montaggio del telaio Fabric frame assembly

NB7.SX

5 inserimento del tessuto tesato
stretched fabric insertion

1 inserire le viti + dado nell'apposito invito
to insert screws + nut into the slot

M4x8
8
DAQ.NEQ8.ZIN

2 giunzione a 45°
45° junction

3 utilizzare un profilo-dima NB e posizionare ogni vite + dado all'altezza di un'asola di aggancio: passo 222 mm. Far scorrere la vite fino a fine corsa
use a NB profile-template and position each screw + nut at the height of a hooking slot: 222 mm pitch. Slide the screw to the end of the stroke.

222

4 serrare la vite con brugola
tighten the screw with Allen key

novità
new items
2019

Finiture Finishings	Alluminio Aluminium	Al
Argento satinato Satinized Silver		NAT
Nero Black		ANE*
Superficie simil-acciaio inox Stainless steel optical		SSO*

Asterisco = la finitura potrebbe non essere in pronta consegna.
Asterisk = finishing not always ready in stock.

Finiture disponibili per profili H = 3012 mm
Finishing available for profiles H = 3012 mm

Quote espresse in millimetri.
Dimensions are in millimeters.

Accessori correlati
Related accessories

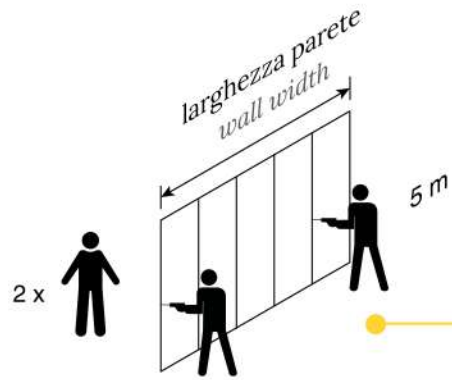

Sistema NB
NB System

19 9,5

Cremagliere NB
Nb Slotted profiles

Rivestimento NB0
NB0 wall cladding

1 h 30'

2 h 30'

PK

10 6

6 h

CG

13

8 h

CR

8 1

6 h

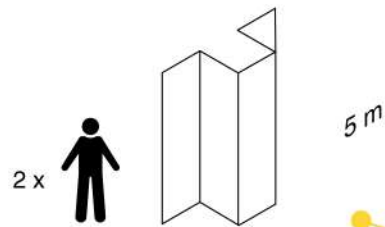

Angolo con NB9
Angle with NB9

Rivestimento NB0
NB0 wall cladding

3 h

5 h

PK-R19

10

-

-

Angolo con CR0
Angle with CR0

8 h

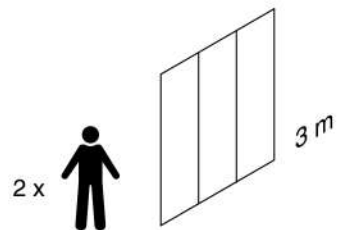

Cremagliere NB
Nb Slotted profiles

Rivestimento NB0
NB0 wall cladding

1 h

2 h

4 h

5 h

4 h

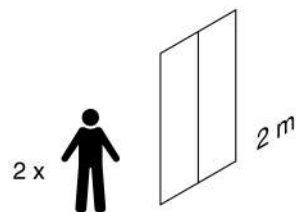

Cremagliere NB
Nb Slotted profiles

Rivestimento NB0
NB0 wall cladding

45 min

1 h 30'

3 h

4 h

3 h 30'

Note tecniche

Technical data

CAPACITÀ DI CARICO

LOADING CAPACITY

Durante l'utilizzo di profili porta-piani in alluminio **si tengano presenti i seguenti fattori:**

- **STRATEGIA DI PRODUZIONE:** la progettazione di ogni profilo, la scelta della lega e le fasi di produzione sono integrate per ottenere da ciascuno di essi la qualità e la tenuta stabilite. La mancanza di questo accorgimento è la ragione per cui le riproduzioni dei nostri prodotti non hanno le necessarie caratteristiche di portata.
- **FISSAGGIO:** i profili sono realizzati per superare la tenuta del tassello a muro (mediamente 350 kg in condizioni ottimali), quindi è fondamentale che l'ancoraggio a parete sia opportunamente eseguito, anche per mezzo di telai quando necessario.
- **PROGETTAZIONE DELLE AMBIENTAZIONI:** le indicazioni di questo catalogo e la professionalità dell'installatore o del progettista, determinano la selezione del giusto profilo e della sua applicazione, secondo le finalità. Sono disponibili svariate opzioni: tipo di foratura - singola o doppia - e montaggio, asse centrale o laterale, distanze ed interassi ed i loro conseguenti accessori.

Keep in mind these factors during the use of aluminium profiles:

- **PRODUCTION STRATEGY:** The design of the different profile sections are decided in relation with the alloy choice and the manufacturing processes. It allows each item to reach the reference loading capacity. This is the main reason why replicated products, found sometimes in the market, do not reach the FitArt loading capacity characteristics.
- **FIXING:** Profiles are conceived in order to exceed the loading capacity of a 5 mm wall plug that reaches in average around 350 kg under normal operating conditions. It is very important to carry out the most suitable fixing to the wall, also using frames if necessary.
- **PLANNING AND DESIGN OF THE STRUCTURE:** The indications of this catalogue and the professional experience of a designer or an installer determine the choice of a right profile and its application. The different profiles options are available regarding: drilling types -single or double- and assembly, central or side load, distances and spans between profiles, and its related accessories.

PROVE DI CARICO

LOADING TESTS

I nostri profili a cremagliera sono sottoposti a severe **prove distruttive con simulazioni in laboratorio.**

Le immagini e il grafico qui riprodotti mostrano un nostro profilo standard, caricato su un singolo dente, resistere fin oltre 400 kg.

Our slotted profiles are subjected to very severe **destructive tests in laboratory simulations.**

The test here described shows a standard profile, with support loaded on a single tooth, standing over 400 kg.

Compressione cremagliera murale NB1

NB1 Wall slotted profile compression

TABELLA
DI DEFAULT
DEFAULT
TABLE

Modo di controllo 1
Velocità 1
Corsa 1
5 mm/min

Control 1
Speed 1
Run 1
5 mm/min

Risultati
Results

	Etichetta provino Label test	Carico compressione Compression load
1	T.01	> 438,819 [daN]

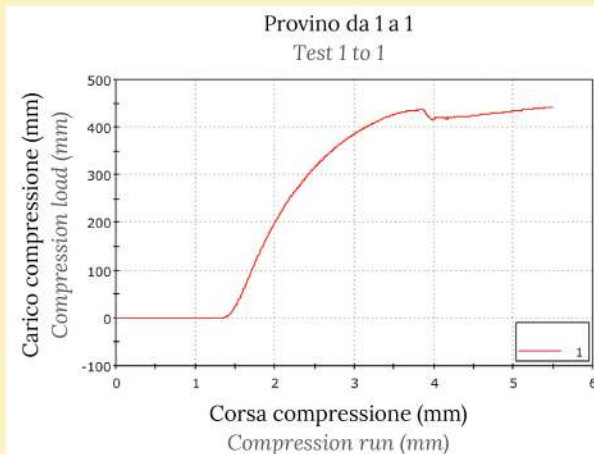

Sezione
cremagliera
Profile
section

Supporto
caricato
Support
loaded

Provino
Test

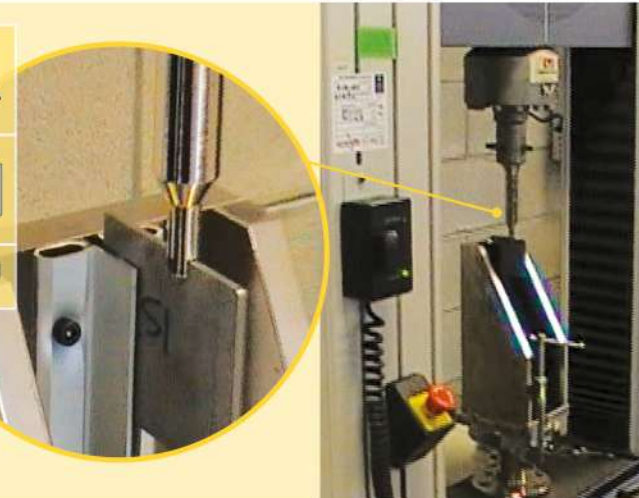
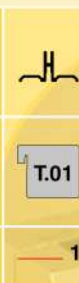

Decliniamo ogni responsabilità per l'utilizzo dei nostri profili con supporti non di nostra produzione, e viceversa, in particolare se prodotti in acciaio inossidabile.

Fit Art disclaims any responsibility for the use of our profiles with supports not of our production, and vice versa, especially the ones realized in stainless steel.



SOLLECITAZIONI AL CARICO

LOADING REACTION

Un carico puntuale su un profilo a cremagliera produce gli stessi effetti di una leva di primo genere (palanchino): **aumentando la distanza dal fulcro (braccio della leva) aumenta proporzionalmente l'effetto della leva.**

The effect of a localized load on a slotted profile is similar to the action of a force applied to a lever (such as a crowbar): **with an increase of the distance (lever arm) from the fulcrum, the lever increases proportionally.**

Ipotesi di comportamento lineare

Hypothesis of linear behaviour

Carico interno al supporto
Inside support load

kg	cm
60	10
30	20
20	30

STESSO EFFETTO DI SOLLECITAZIONE
SAME STRESS EFFECT

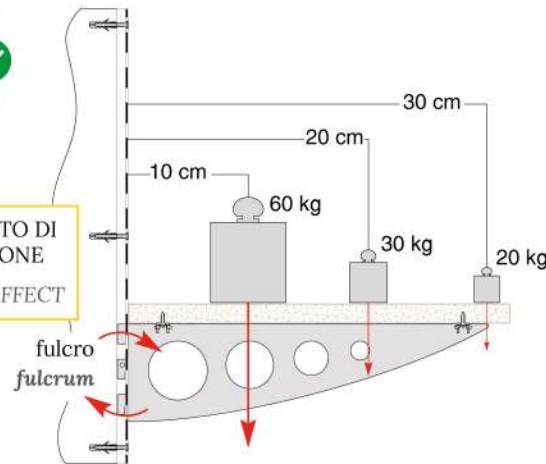

Carichi a sbalzo: comportamento non lineare

Overhang load: no more valid linear behaviour

Carico a sbalzo
Overhang load

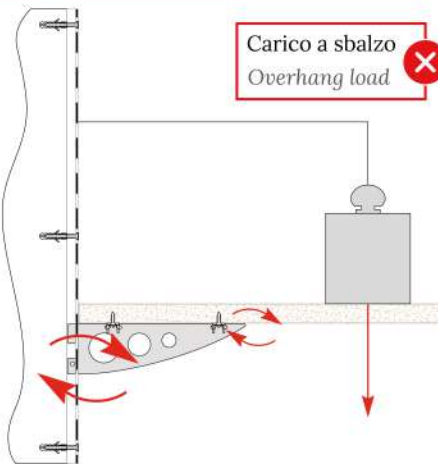

CATEGORIE DI PORTATA

LOADING CATEGORIES

Poiché dai dati tecnici finora considerati **non si può assegnare alcuna portata nominale.**

A titolo puramente indicativo abbiamo suddiviso i profili in categorie di portata subordinate alle **sezioni** ed alla **disposizioni degli ancoraggi.**

According to the technical data provided in these pages, it becomes very difficult to assign a nominal loading capacity in average conditions.

Anyway the profiles can be divided into the following loading categories, considering the **section dimension** and how the **fixings are positioned.**



ALTA
HIGH

- Profili
- con fissaggi doppi
 - con tanti punti di ancoraggio
 - inseriti all'interno di montanti

- Profiles
- with double fixings
 - with many anchor points
 - inserted into the uprights

NB1 / NB2
LMK + HLE
CG1 / CG2
PK1 / PK2
RMC + TCN
RP1 / RP2
RDC + RD2
FDC + RD2



MEDIA
MEDIUM

- Profili
- con fissaggi doppi con passo maggiore di 20 cm
 - con fissaggi su un lato a meno di 20 cm di distanza

- Profiles
- with double fixings with more than 20 cm pitch
 - with single side fixings at less than 20 cm distance

NB7 / NB3
CR1 / CR2
CG7 / PK7



BASSA
LOW

- Profili
- con fissaggi su un lato con passo maggiore di 20 cm
 - CONCEPITI PER INCASSO con sezioni contenute

- Profiles
- with single side fixings at more than 20 cm
 - profiles with restrained section
CONCEIVED TO BE EMBEDDED

CR7
serie ad
incasso

CR7
embedded
series